

MD-150729

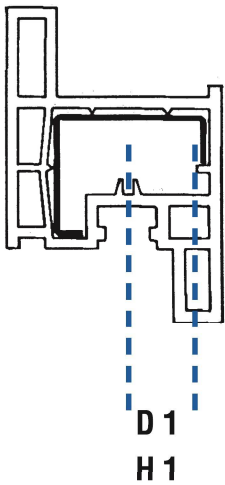

Tornillo para herraje

Tipo	Medidas Mm	Superficie	Referencia	Cant. UE	Caj. UE
D 1	4,2 x 16	galv., plata	E-12562-16-0.1	1000	12
D 1	4,2 x 20	galv., plata	E-12562-20-0.1	1000	12
D 1	4,2 x 22	galv., plata	E-12562-22-0.1	1000	12
D 1	4,2 x 25	galv., plata	E-12562-25-0.1	1000	12
D 1	4,2 x 30	galv., plata	E-12562-30-0.1	1000	12
D 1	4,2 x 35	galv., plata	E-12562-35-0.1	1000	6
D 1	4,2 x 40	galv., plata	E-12562-40-0.1	1000	6
D 1	4,2 x 45	galv., plata	E-12562-45-0.1	1000	4
D 1	4,2 x 55	galv., plata	E-12562-55-0.1	1000	4
D 1	4,8 x 47	galv., plata	E-12562-47-0.1	1000	4 *



Tornillo para herraje Super E

D 1	4,2 x 25	plata	H-00198-25-0-2	1000	12
D 1	4,2 x 35	plata	H-00198-35-0-2	1000	6

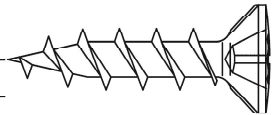

Tornillo para herraje Acero Inox

D 1	4,2 x 25	Acero inox.	E-12567-25-0.0	1000	12
D 1	4,2 x 35	Acero inox.	F-12567-35-0.0	1000	35



Tornillo cabeza blanca

D 1	4,2 x 25	cabeza blanca	E-14543-25-0.7	1000	12
D 1	4,2 x 30	cabeza blanca	E-14543-30-0.7	1000	12
D 1	4,2 x 35	cabeza blanca	E-14543-35-0.7	1000	6



Tornillo de reposición

H 1	4,8 x 25	galv., plata	E-12566-25-0.1	1000	12
H 1	4,8 x 38	galv., plata	F-12566-38-0.1	1000	6

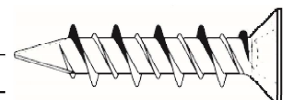

Tornillo autotaladrante

B 1	3,9 x 25	galv., plata	E-12563-25-0.1	1000	12
B 1	3,9 x 32	galv., plata	E-12563-32-0.1	1000	12
B 1	3,9 x 38	galv., plata	E-12563-38-0.1	1000	6

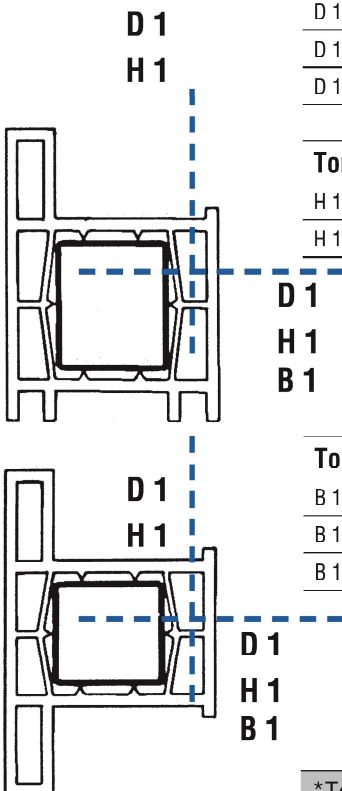

*Tornillo 4,8 x 47 para la fijación de los herrajes:

- UNITAS 16 (pivotes)
- Correderas plegables G.U-923 (bisagras y soporte de carros)
- Corredera-paralela-abatible G.U-966 (carros y manilla)

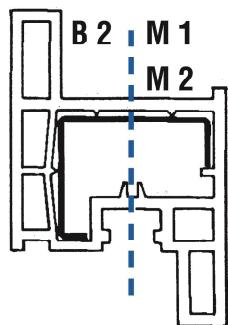

Tornillo para refuerzo

Tipo	Medidas Mm	Superficie	Referencia	Cant. UE	Caj. UE
B 2	3,9 x 16	galv., Plata	E-12569-16-0.1	1000	12
B 2	3,9 x 19	galv., Plata	E-12569-19-0.1	1000	12

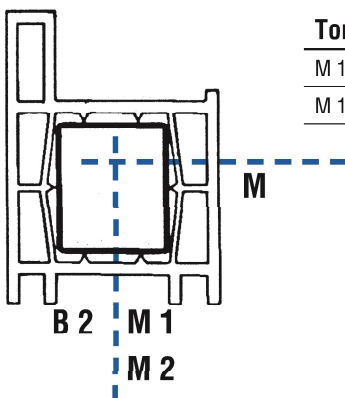
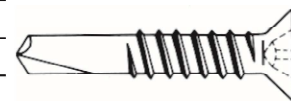

Tornillo para refuerzo, rosca métrica. Cabeza gota de sebo.

M 1	M 4 x 13	galv., Plata	E-12573-13-0.1	1000	12
M 1	M 4 x 16	galv., Plata.	E-12573-16-0.1	1000	12

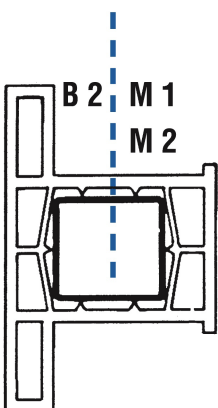
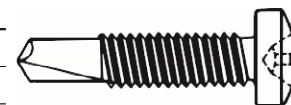

Tornillo para refuerzo, rosca métrica

M 2	M 4 x 13	galv., Plata	E-12575-13-0.1	1000	12
M 2	M 4 x 16	galv., Plata	E-12575-16-0.1	1000	12
M 2	M 4 x 19	galv., Plata	E-12575-19-0.1	1000	12
M 2	M 4 x 22	galv., Plata	E-12575-22-0.1	1000	12
M 2	M 4 x 25	galv., Plata	E-12575-25-0.1	1000	12
M 2	M 4 x 32	galv., Plata	E-12575-32-0.1	1000	12



Tornillo para batiente

Tipo	Medidas Mm	Superficie	Referencia	Cant. UE	Caj. UE
B 5	4,8 x 55	galv., Bicrom.	E-12576-55-0.1	100	12
B 5	4,8 x 65	galv., Bicrom.	E-12576-65-0.1	100	12
B 5	4,8 x 80	galv., Bicrom.	E-12576-80-0.1	100	12
B 5	4,8 x 95	galv., Bicrom.	E-12576-95-0.1	100	6

Cada caja incluye tapas blancas

Tapa suelta	blanco	19000011700-C	100	
Tapa suelta	marrón	19000012700-C	100	

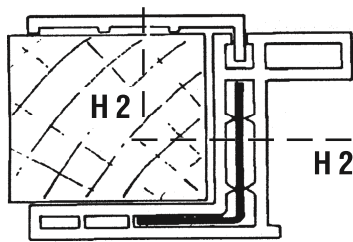
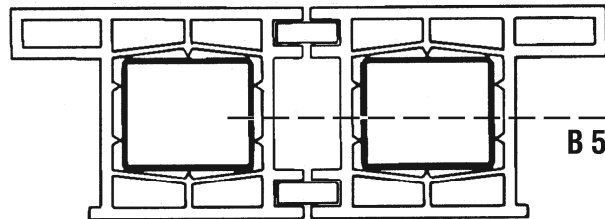
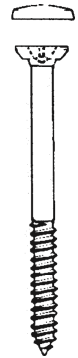

Tornillo autotaladrante para batiente

Tipo	Medidas Mm	Superficie	Referencia	Cant. UE	Caj. UE
H 2	5,3 x 35	galv., Bicrom.	E-12577-35-0.1	100	12
H 2	5,3 x 45	galv., Bicrom.	E-12577-45-0.1	100	12
H 2	5,3 x 55	galv., Bicrom.	E-12577-55-0.1	100	12
H 2	5,3 x 65	galv., Bicrom.	E-12577-65-0.1	100	12
H 2	5,3 x 80	galv., Bicrom.	E-12577-80-0.1	100	12
H 2	5,3 x 95	galv., Bicrom.	E-12577-95-0.1	100	6

Cada caja incluye tapas blancas

Tapa suelta	blanco	19000011700-C	100	
Tapa suelta	marrón	19000012700-C	100	

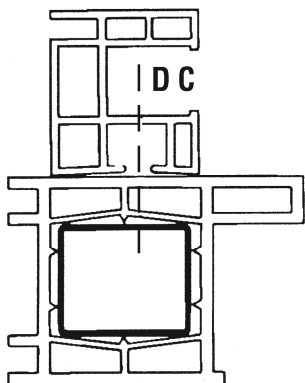
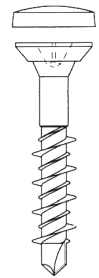

Tornillo para fijación de guías

Tipo	Medidas Mm	Superficie	Referencia	Cant. UE	Caj. UE
	D / d / L				
D C	9,5 / 6,8 / 9,0	galv., Bicrom.	E-12578-01-0-3	1000	12
D C	10,5 / 7,4 / 13,0	galv., Bicrom.	E-12578-02-0-3	1000	12
D C	12,0 / 8,4 / 12,0	galv., Bicrom.	E-12578-03-0-3	1000	12
D C	11,0 / 8,6 / 10,0	galv., Bicrom.	E-12578-04-0-1A	1000	12
D C	11,0 / 8,4 / 12,0	galv., Bicrom.	E-12578-05-0-3	1000	12
D C	9,5 / 6,8 / 12	galv., Bicrom.	E-12578-06-0-3	1000	12
D C	4 x 9-8	galv., Bicrom.	E-12578-08-0-3	1000	12



Tabla de equivalencia del tornillo DC según perfil

Modelo	Color	Perfil
Tamaño 01	Amarillo	Brüggmann
Tamaño 02	Rojo	KBE, Rehau, Thyssen
Tamaño 03	Blanco	Aluplas, Trocal, Schüco
Tamaño 04	Metálico	Kömmerling
Tamaño 05	Verde	Hocoplast
Tamaño 06	Amarillo	Veka

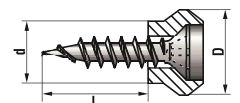